

# Operating manual

MODEL : PC-100

POS ECR Interface

ACOM

## Gratitude

Thank you for your purchasing our product, we are always trying to serve you with a good quality as a reliable weighing instrument and enhanced features to supporting various kinds of conveniences of conveniences

## Specifications

Items	PC-100 ( ECR Interface )		
	6 kg	15 kg	30 kg
Minimum graduation	2 g	5 g	10 g
Maximum Tare	Full tare		
A/D update speed	9 times / sec.		
Internal resolution	60,000		
Display(digit)	VFD Weight(5)		
Operating temp.	-10°C ~ 40°C		
Humidity	RH.35% ~ 85%(no condensation)		
Power source	AC 115, 230 / 50, 60Hz		
Power consumption	AC only Approx. 6W		
Fuse rating	250V / 0.2A		
Platter size/mm(inch)	350(13.8) x 270(10.6)		
Size mm(inch)	Poled -> 365(14.4) x 365(14.4) x 470(18.5)		

## Precautions

- Place the scale on the flat and rigid surface
- Place the scale far away from heavy EMI noises
- Level the scale with adjusters
- Do not subject the impact on the scale
- Do not use cleaner included solvent or sinner
- The scale must be calibrated by authorized person initially and regularly under an each country's related law

# Names of the parts

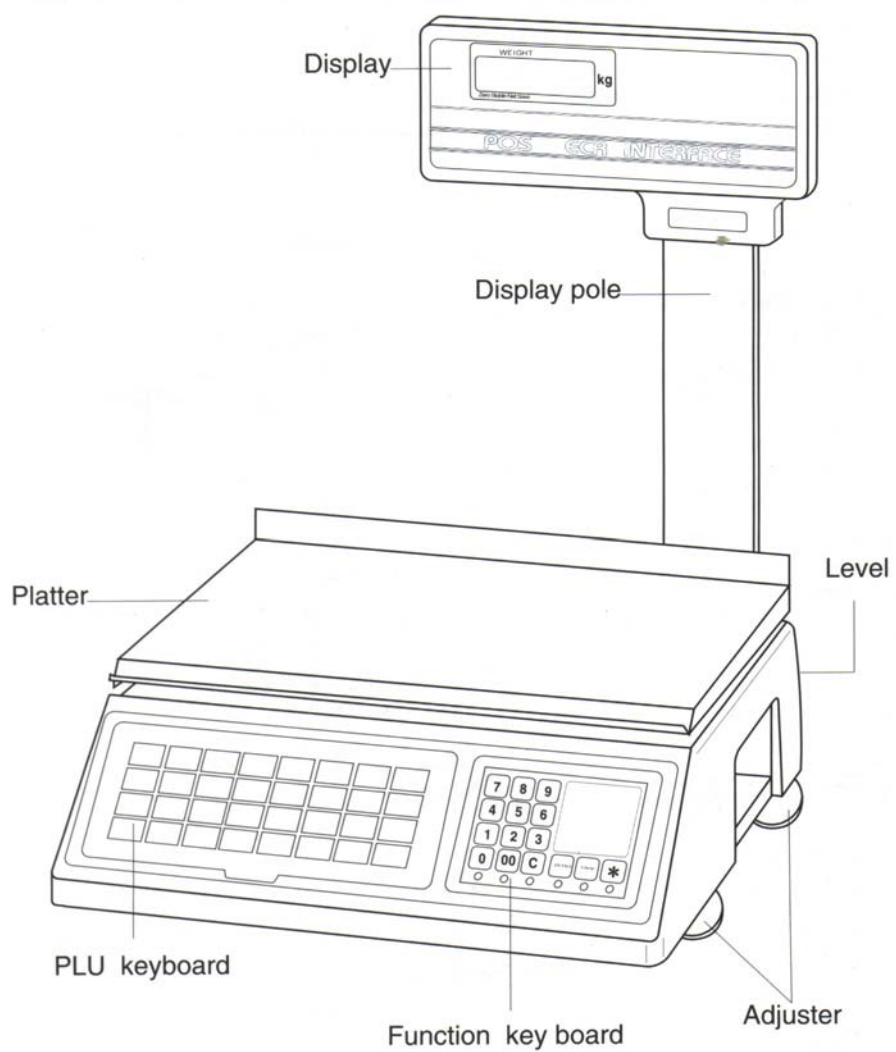

## Unpacking and assembly

Open the carton box and take out packed scale

Place the scale on the rigid desk.

Remove packing Styrofoam and vinyl packaging

Put in display assembly into the display bracket of the scale.

Fasten display pole with two of M4 screws.

Arranging harness wire into the display pole.

Fasten bottom cover on display bracket with four of M3 screws.

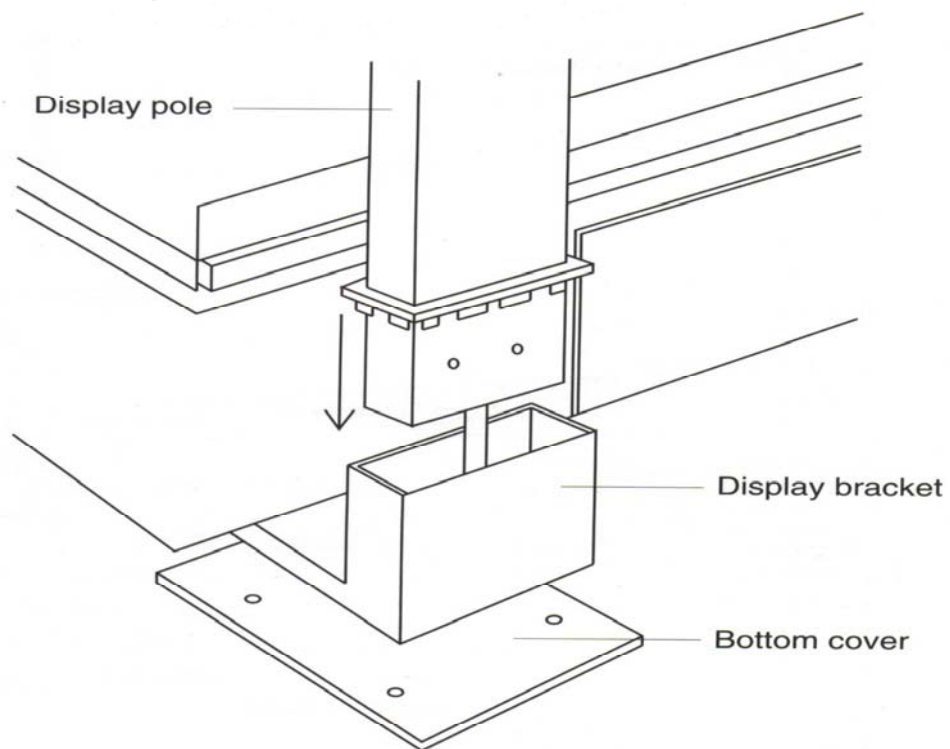

## Function of each key

Name of key	Function
0 9	This key is used to set numbers
C	This key used to clear numbers
ZERO	This key used to correct zero shift, activated on stable marked
TARE	This key used to entering tare weight, activated on stable marked
*	Printer version This key is used to print Battery version This key is used to restart the scale from standby mode in battery used

## Designators and functions

Designators	Functions
“ZERO”	It indicates centered zero
“STABLE”	It indicates stable status in weighing
“NET”	It indicates tare entered
“BATT”	It indicates battery using and exhausted when blink

## Using Battery(optional)

Scale works by battery when not in using AC power, please read carefully for the best condition of rechargeable battery, while scale is being worked by battery the designator “BATT” is indicated

First operation from delivery

The battery may be exhausted during a long delivery or other reasons, please charge the battery fully.

Charging times

Times for a full charged battery are 11 hours with scale turned on and 15 hours with scale turned off. When you use a scale out door it is recommended charge the battery after message “Lo-bAt”(low battery)

Voltage indication

Scale indicates a voltage either turned on by power switch or restarting from stand by mode by “\*”key

Warning voltage

The battery exhausted to lower lever then scale warns “Lo-Bat” with beep Sound three times, this means battery will work a few hours more, please Charge the battery

Power down voltage

If the scale is left after a message “Lo-Bat” for a long time then scale will Put power down mode itself, at this moment turn off power switch immediately and commence the charging battery

Stand by mode

Scale is left without weighing or key input for a time which has been set to Waiting time then scale will jump into the stand by mode in order to saving a battery power and scale will wake up by pressing “\*”key, waiting time is programmable.

## Operation

### 1. Setting a waiting time(optional)

- Press “\*” key with empty platter(zero status)
- Press “\*” key again, number displayed means waiting time in second
- Waiting time changes by pressing “TARE” key 15 seconds interval up to 3 minutes, choose a time  
\*Set time “0”for a continues operations
- Press”\*”key to programming and exit to normal mode
- Remove commodity
- Remove tare and press “TARE” key, designator “NET” it turned off

timE

30

45

0

0

0

### 2. General weighing

Always confirm “ZERO” mark before weighing and read weight after “STABLE” marked on

- Put commodity on the platter
- Read weight after stable marked on
- Remove commodity

324

324

0

### 3. Weighing with tare

#### A. Unknown Tare

- Place the tare on the platter 156
- Press “TARE” key, designator “NET” is turned on 0
- Put commodity on the tare 324
- Read weight after designator “STABLE” marked on 324
- Remove commodity 0
- Remove tare and press “TARE” key, designator “NET” is turned off 0

### 4. Errors table

Error	Meaning	Treatment
ZERO	Initial zero error	Remove weight on the platter and Restart the scale Otherwise call service
OF-1	Add up over flow	Clear sum total
OF-2	Transaction over flow	Clear sum total
OF-3	Daily total over flow	Clear daily total
ADC	Analog circuit Failure	Call service
EEP	Memory failure	Call service
PARA	Parameter failure	Call service



## ECR Interface

### Instructions for Setting the RS-232 Port

If you have Purchased your PC-100 scale with the RS-232 kit you will be Able to interface you scale to a PC or virtually any ECR(Electronic Cash Register) if you do not have this Feature or aren't sure. Please contact your local ACOM Authorizes Dealer to assist you. The following page will explain the RS-232setup.

#### Type Setting:

The PC-100 communicates using the following protocol: 9600 Baud, Even Parity, 7 Data, and 1 Stop Bit. This is fixed and cannot be changed However, there are different request codes and response data that can be selected. The following explains how set the different Type Settings.

1. Turn the scale OFF
2. Press and hold down the \* key while you turn the scale ON
3. Release the \* key ones you hear the scale beep
4. You will see a value in the Unit Price display. You may change this value according to the chart below.
5. Once you are done setting the value, press the \* key

Basic Description	Type Setting
Disable RS-232 Port	00
NCI General Interface (Most P.O.S. Systems)	01
NCI ECR Interface (Most Cash Registers)	02
Toledo 8213 (Many Cash Register)	03
Stream Mode	10
Hand Shake Mode	20

See next page for Cash Register and personal computer model cross reference chart. You will find that the PC-100 scale will interface to the most popular makes and models.

There are also cable diagrams on the following pages for most devices.

Make	Setting	Models
Casio	01	SA-3000,all Casios with RS-232 scale ports
CRS	02	CRS-3000
DataSym	02	DT-2000 and all newer models that follow
IBM PC	01	IBM PCs and compatible with 25 pin serial ports
IBM PC	01	IBM PCs and compatible with 9 pin serial ports
NCR	02	2170, 7452, 7453, 7445 Falcon, and all newer models that follow
Omron	02	RS-4841,4810, 4541, 4341, 4310, 4510, 4540, Vantage 7000, and all newer models that follow
Panasonic	02	Panasonic ECRs with serial interface
Samsung	02	ER-550, 650, 6500, 6540
Samsung	02	ER-5100, 5140
Sanyo	03	All older models that have RS-232 scale interface
Sharp	03	ER*A880,A850,A750,A650,A570,A550S,A470,A460, A430 and all newer models that follow
Sharp	03	UP600, 700, and all newer model that follow
Swintec	02	2250, with 25 pin serial ports
Swintec	02	2250, with 9 pin serial ports
Uniwell	03	UX 70-05, UX60-05, UX 43-05, TX850, SX6000, SX7000

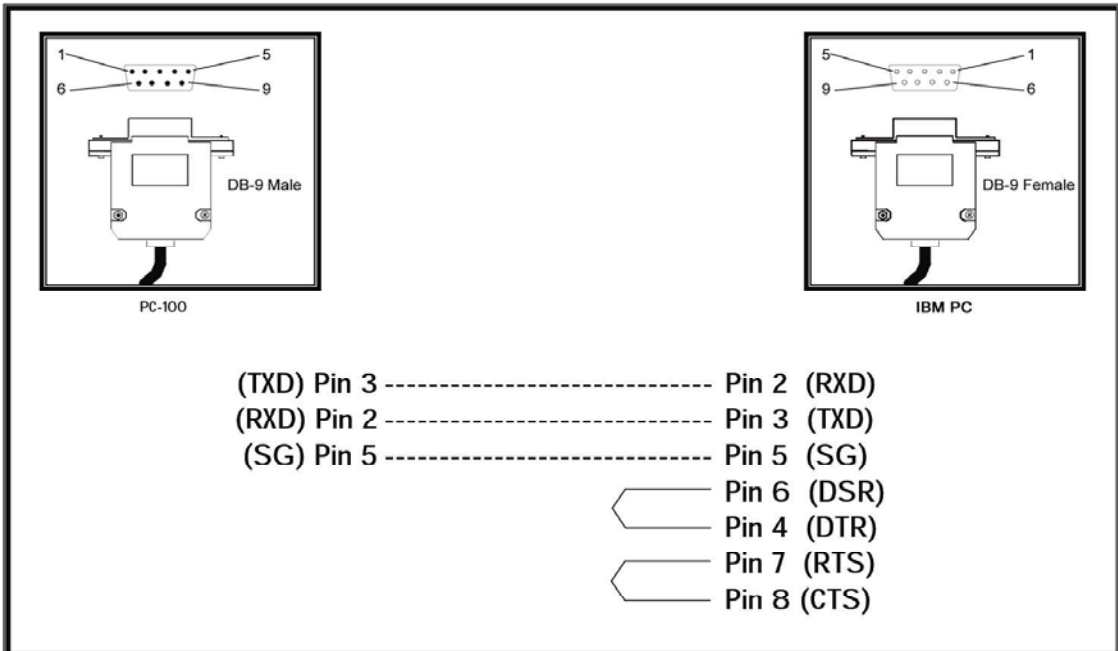
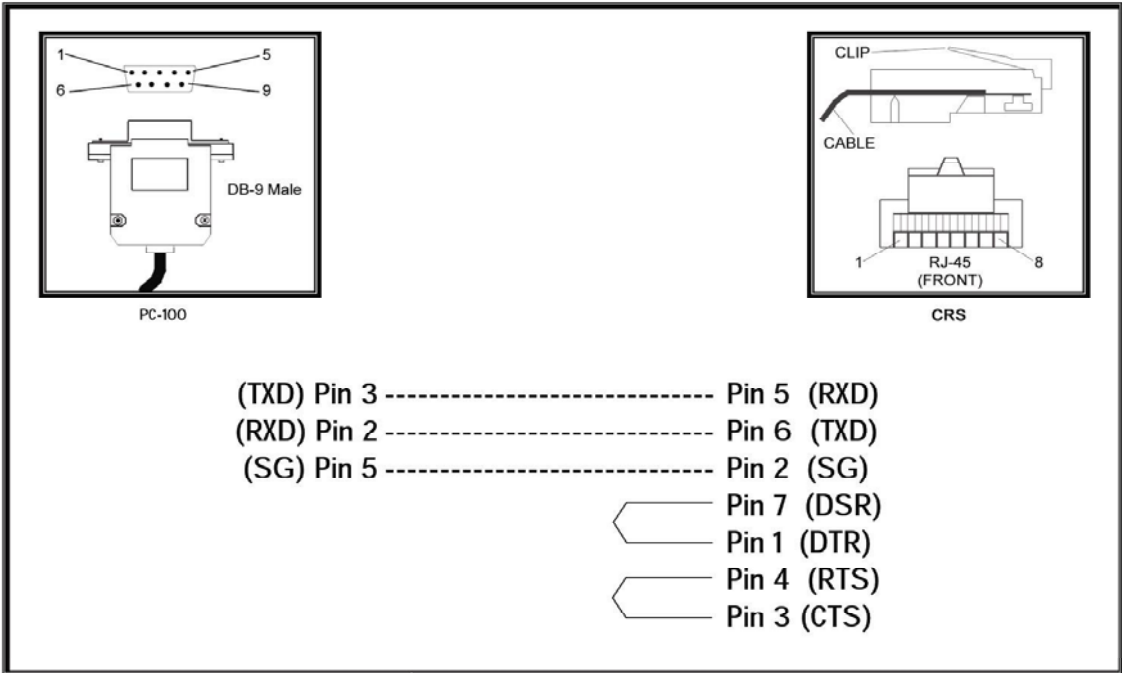

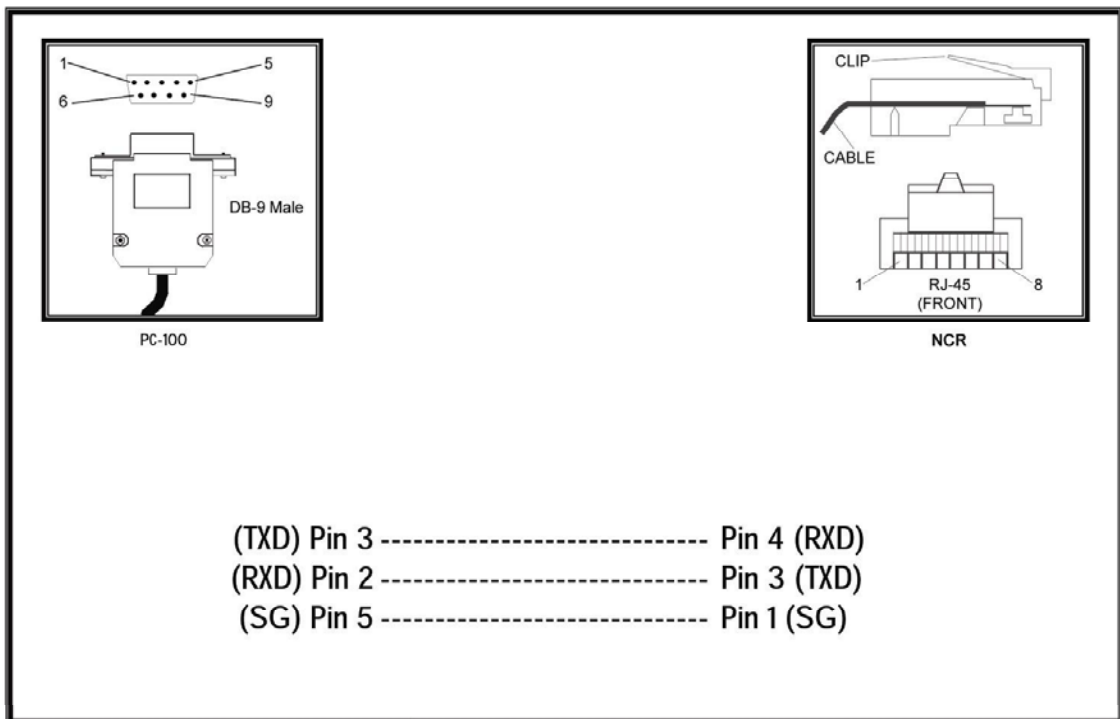
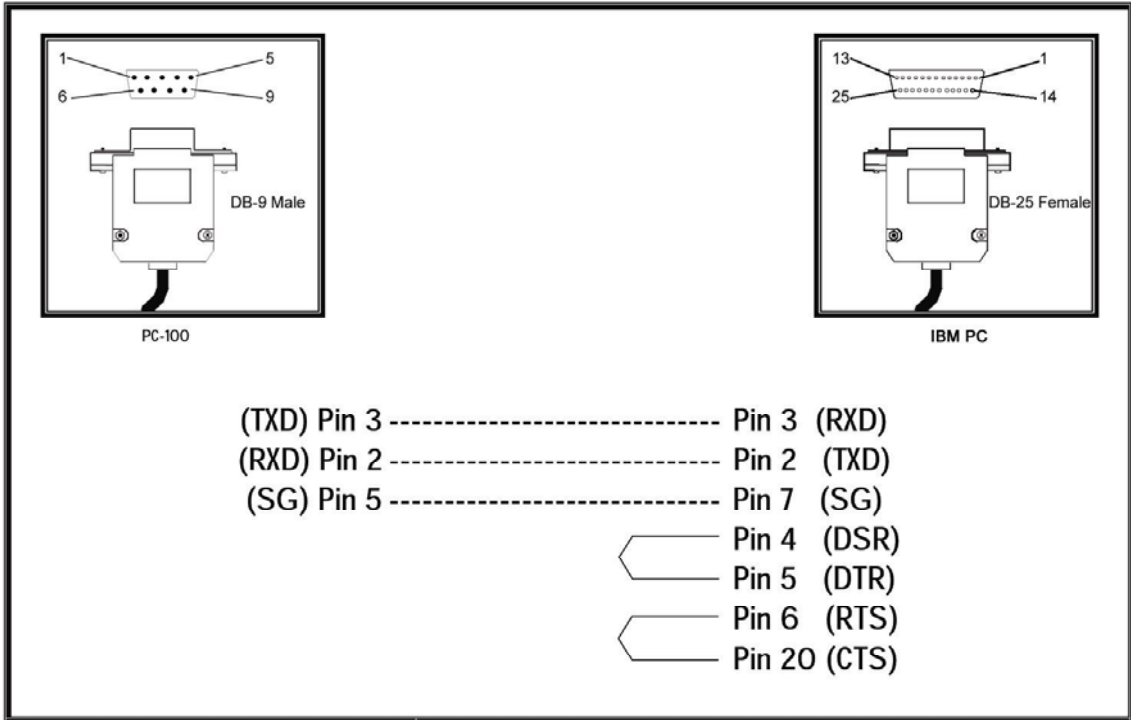

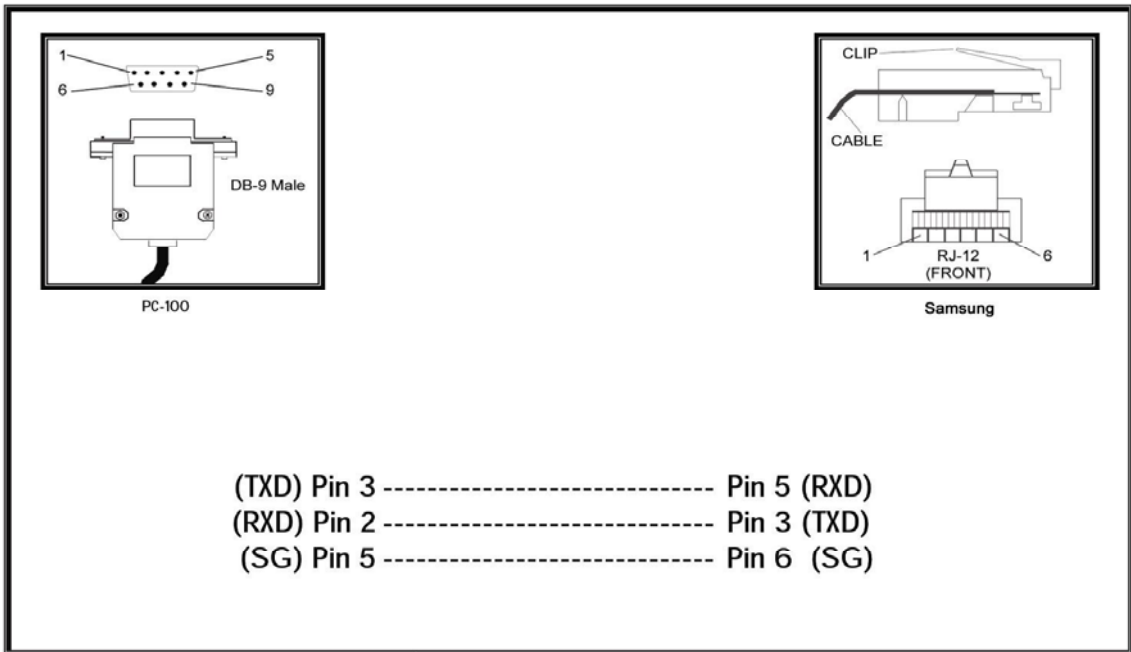
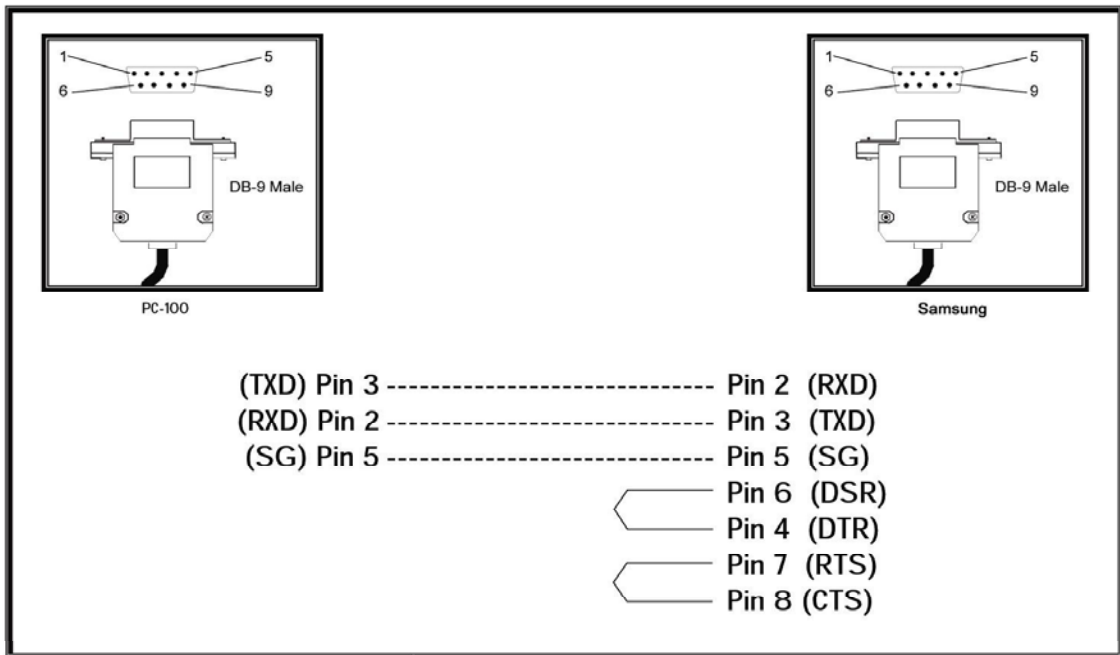

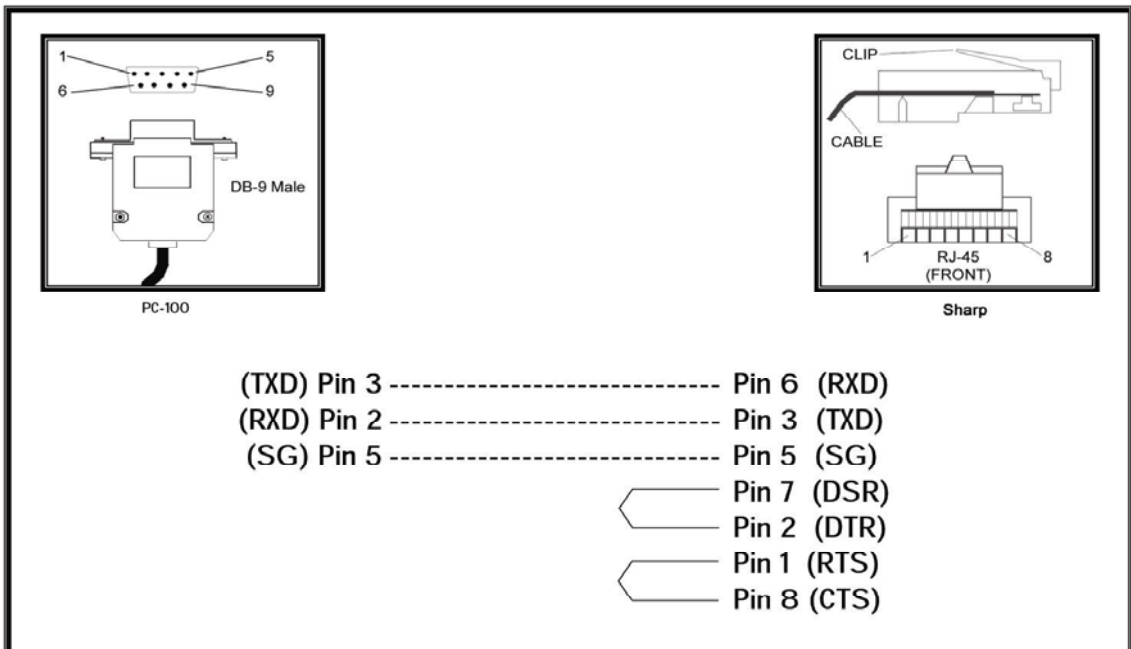
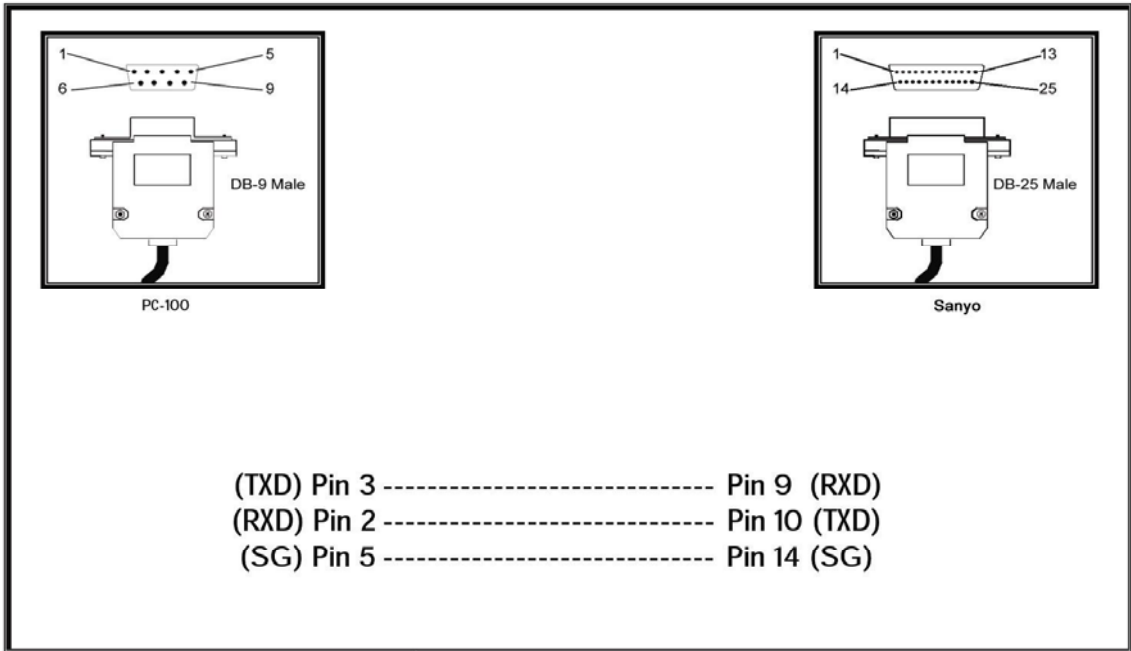

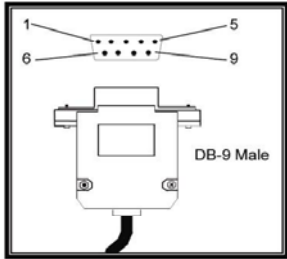

PC-100

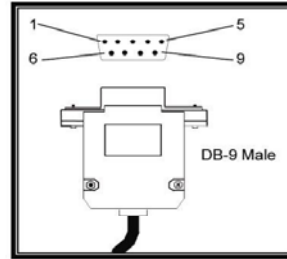

Swintec

(TXD) Pin 3	-----	Pin 2 (RXD)
(RXD) Pin 2	-----	Pin 1 (TXD)
(SG) Pin 5	-----	Pin 3 (SG)
		Pin 4
		Pin 8
		Pin 9

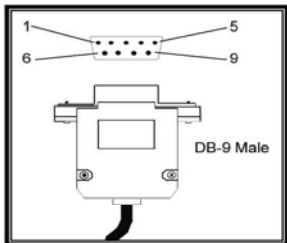

PC-100

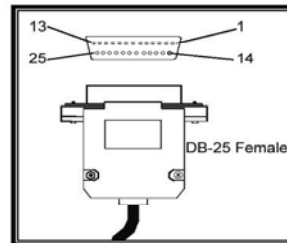

Swintec

(TXD) Pin 3	-----	Pin 3 (RXD)
(RXD) Pin 2	-----	Pin 2 (TXD)
(SG) Pin 5	-----	Pin 7 (SG)

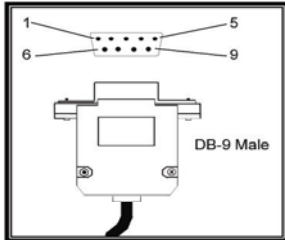

PC-100

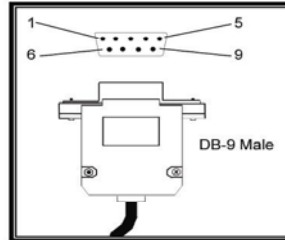

Uniwell

(TXD) Pin 3 -----	Pin 3 (RXD)
(RXD) Pin 2 -----	Pin 2 (TXD)
(SG) Pin 5 -----	Pin 7 (SG)
	Pin 4 (DSR)
	Pin 5 (DTR)
	Pin 8 (RTS)
	Pin 9 (CTS)



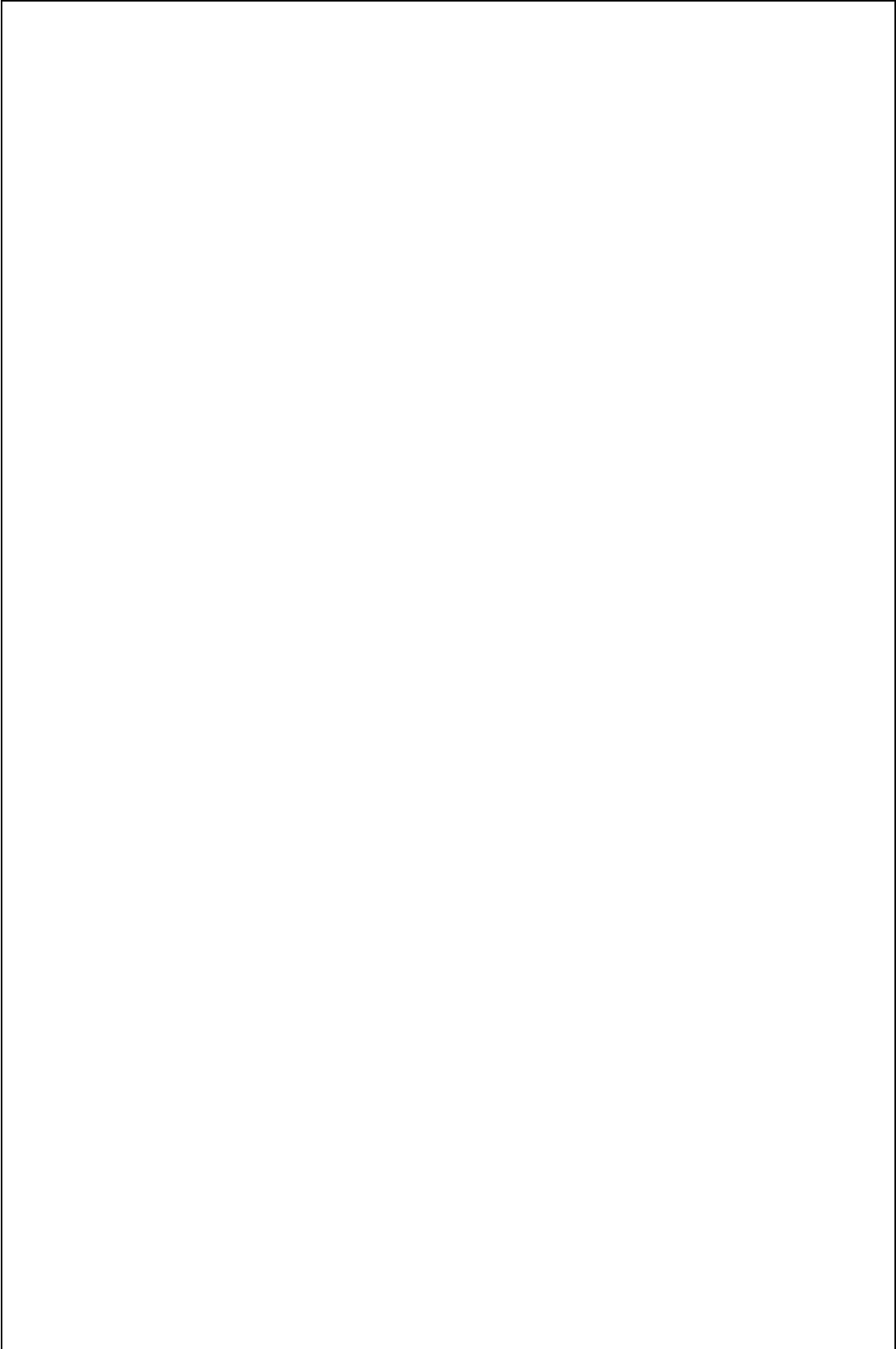

# ACOM Inc.

#679-1, Yugo-ri, Gunnae-myuun, Pocheon-gun,  
Kyunggi-do, 487-811 Korea